

## 2. OPERATION CHART: QW-1664

### GENERAL GUIDE

- Press **(C)** to change from mode to mode.
- Hold down **(C)** for one or two seconds in any mode to switch back to the Timekeeping Mode.

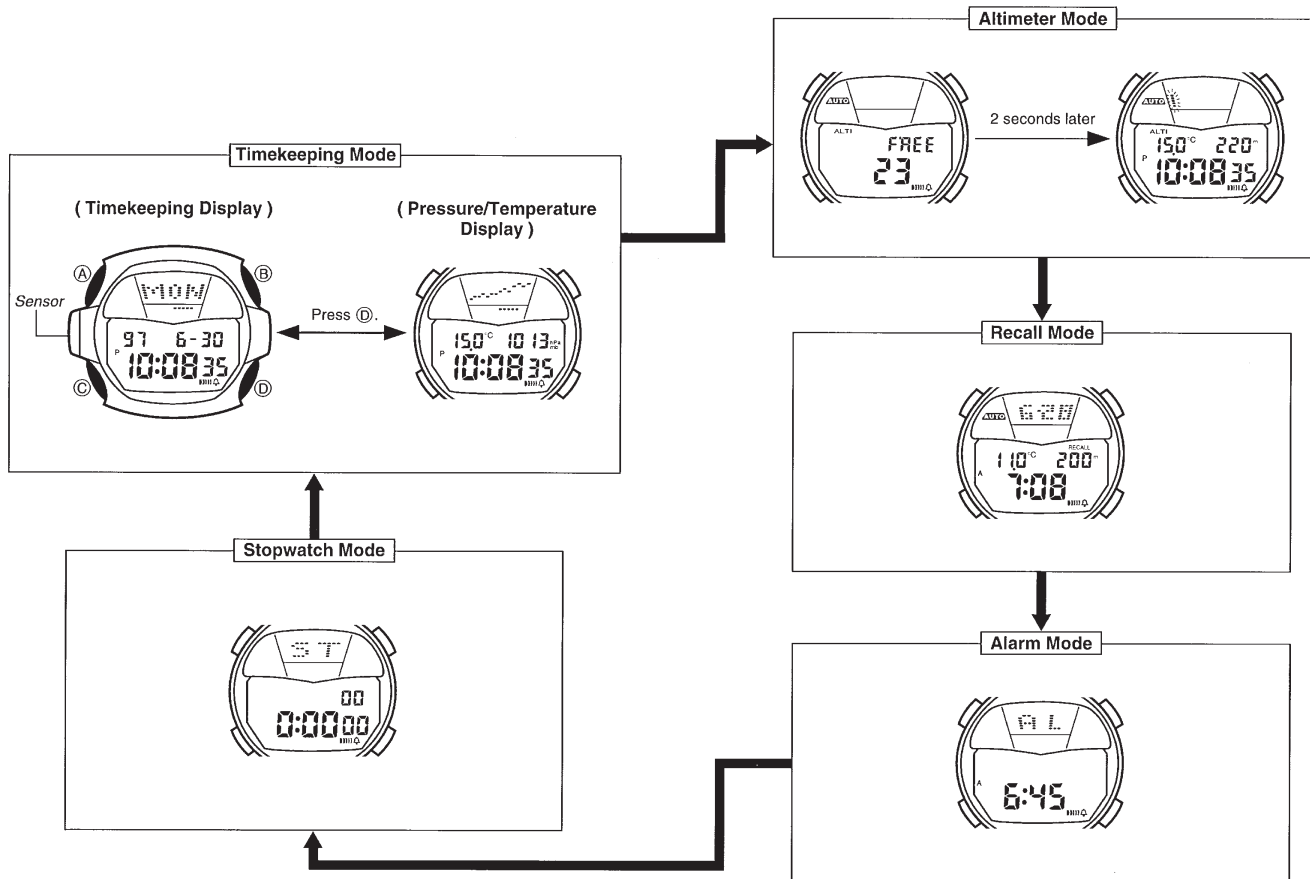

### BACKLIGHT

This watch features an electroluminescent (EL) backlight that helps you easily read the face, even in total darkness. Its Auto Backlight function automatically lights the watch face whenever you turn your wrist towards your face.

#### Note

- The backlight of the watch employs an electroluminescent (EL) light, which loses illuminating power after very long use.
- Frequent use of the backlight shortens the battery life.
- The illumination provided by the backlight may be hard to see when viewed under direct sunlight.
- The watch will emit an audible sound whenever the display is illuminated. This is caused by a transistor that vibrates when the EL panel lights up. It does not indicate malfunction of the watch.
- The backlight automatically turns off whenever an alarm sounds or when you press the **(C)** or **(D)** button.

#### To manually turn on the backlight



In the Timekeeping Mode or the Altimeter Mode, press **(B)** to illuminate the display for about two seconds.

- The backlight remains lit for about two seconds from the point you press **(B)**, even if it is already lit when you press **(B)**. If you keep **(B)** depressed for one or two minutes, the backlight will automatically turn off.

#### To switch the auto backlight function on and off

In the Timekeeping Mode, hold down **(D)** for one or two seconds to turn the auto backlight function on and off.

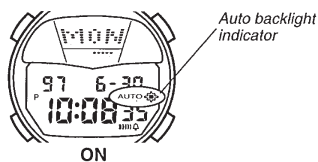

- The auto backlight indicator is shown on the display in all modes while the auto backlight function is on.
- In order to protect against running down the battery, the auto backlight function is automatically turned off approximately two or three hours after you turn it on. Repeat the above procedure to turn the auto backlight function back on if you want.
- Pressing **(B)** in the Timekeeping Mode or Altimeter Mode illuminates the display for about two seconds, regardless of the auto backlight function on/off setting.

#### About the Auto Backlight function

While the Auto Backlight function is turned on, the backlight automatically lights for about two seconds in any mode whenever you position your wrist as described below.

#### Important!

Avoid wearing the watch on the inside of your wrist. Doing so causes the Auto Backlight to operate when it is not needed, which shortens battery life.

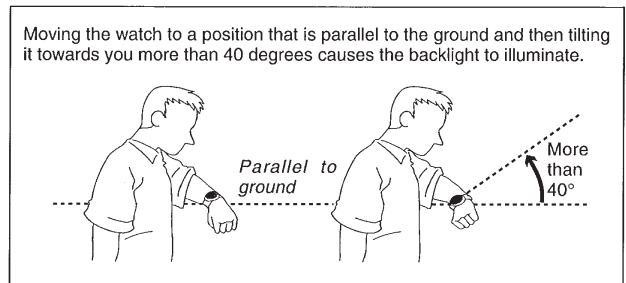

- The backlight may not illuminate if the face of the watch is more than 15 degrees off parallel as shown below. Make sure that the back of your hand is parallel to the ground.

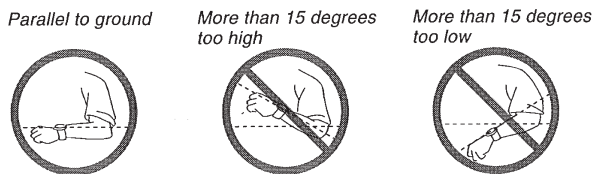

- Static electricity or magnetic force can interfere with proper operation of the auto backlight function. If the auto backlight does not illuminate, try moving the watch back to the starting position (parallel with the ground) and then tilt it back toward you again. If this does not work, drop your arm all the way down so it hangs at your side, and then bring it back up again.
- Under certain conditions the backlight may not light until about one second or less after turn the face of the watch towards you. This does not necessarily indicate malfunction of the backlight.

### Warning!

- Never try to read your watch when mountain climbing or hiking in areas that are dark or in areas with poor footing. Doing so is dangerous and can result in serious personal injury.
- Never try to read your watch when running on a roadside or in any other location where there might be vehicular or pedestrian traffic. Doing so is dangerous and can result in serious personal injury.
- Never try to read your watch when riding on a bicycle or when operating a motorcycle or any other motor vehicle. Doing so is dangerous and can result in a traffic accident and serious personal injury.
- When you are wearing the watch, make sure that its auto backlight function is turned off before riding on a bicycle or operating a motorcycle or any other motor vehicle. Sudden and unintended operation of the auto backlight can create a distraction, which can result in a traffic accident and serious personal injury.

## TIMEKEEPING FUNCTION

### To set the time and date

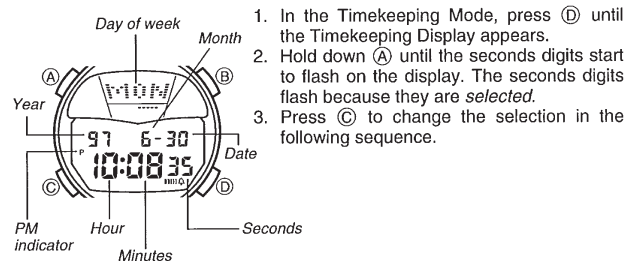

- In the Timekeeping Mode, press (D) until the Timekeeping Display appears.
- Hold down (A) until the seconds digits start to flash on the display. The seconds digits flash because they are selected.
- Press (C) to change the selection in the following sequence.

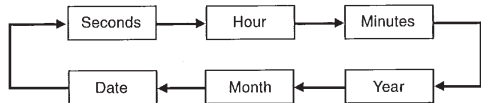

- While the seconds digits are selected (flashing), press (D) to reset the seconds to "00". If you press (D) while the seconds count is in the range of 30 to 59, it is reset to "00" and 1 is added to the minutes. If the seconds count is in the range of 00 to 29, the minutes count is unchanged.
- Press (B) to switch between the 12-hour and 24-hour formats.
- While any other digits (besides seconds) are selected (flashing), press (D) to increase the number. Holding down (D) changes the current selection at high speed.
- After you set the time and date, press (A) to return to the Timekeeping Mode (Timekeeping Display).
- The day of the week is automatically set in accordance with the date.
- The date can be set within the range of January 1, 1995 to December 31, 2039.
- If you do not operate any button for a few minutes while a selection is flashing, the flashing stops and the watch goes back to the Timekeeping Mode automatically.

## BAROMETER FUNCTIONS

This watch uses a pressure sensor to measure air pressure. This sensor can be calibrated.

### Important!

The barometer that is built into this watch measures changes in air pressure, which you can then apply to your own weather predictions. It is not intended for use as a precision instrument in official weather prediction or reporting applications.

### Example barometer applications

- Before going mountain climbing, you can take readings to find out the probable upcoming weather.
- You can predict the weather for golf or other outdoor activities.

### About barometric measurements

The barometer automatically takes measurements every two hours (starting from midnight), regardless of what mode you are in. Barometric pressure measurements are also taken every five seconds for three minutes after you display the Timekeeping Mode's Barometric pressure/Temperature display. The last measurement result, along with the current temperature is displayed in the Barometric pressure/Temperature display.

### Understanding the barometer display

- Use (C) to enter the Timekeeping Mode.
- Press (D) to display the Barometric Pressure/Temperature Display.

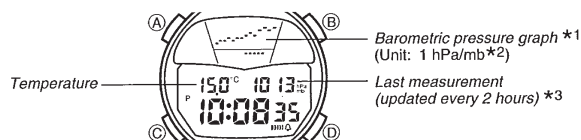

( Barometric Pressure/Temperature Display )

- \*1 The barometric pressure graph shows the barometric readings for the past 26 hours. The flashing point on the right of the display is the point for the last measurement.
- \*2 Some countries call this unit hecto-pascal (hPa), while other countries call it millibars (mb). It really makes no difference, because 1 hPa = 1 mb. In this manual, we will refer to hPa/mb or hPa (mb).
- \*3 The display shows "---- hPa/mb" if a measured value falls outside the range of 460 hPa/mb to 1100 hPa/mb. The normal display will return as soon as the pressure returns within the allowable range.

### Using the barometric pressure graph

Changes in barometric pressure are caused by changes in the weather and temperature. The following shows how to interpret the data that appears on the barometric pressure graph.

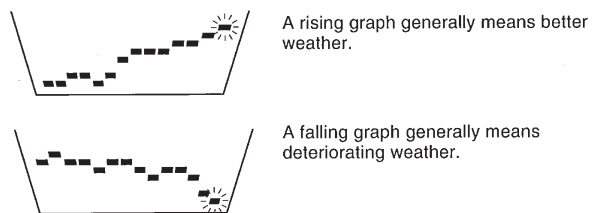

Note that if there are sudden changes in weather or temperature, the graph line of past measurements may run off the top or bottom of the display. The entire graph will become visible once barometric conditions stabilize.

The following conditions cause the barometric pressure measurement to be skipped, with the corresponding point on the barometric pressure graph being left blank.

- Barometric reading that is out of range (460 hPa/mb to 1100 hPa/mb)
- Sensor malfunction
- Dead battery

### Calibrating the barometric pressure measurement

The sensor of this watch is calibrated at the factory before shipment and further adjustment is normally not required. If noticeable error is found in the barometric pressure readings produced by the watch, you can adjust it to correct the error.

### Important!

Incorrectly calibrating the barometric pressure measurement of this watch can result in incorrect readings. Compare the readings produced by the watch with those of another reliable accurate barometer.

### To calibrate the barometric pressure

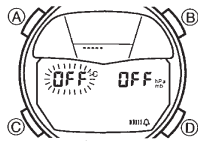

1. In the Timekeeping Mode, use **D** to display the barometric pressure and temperature.
2. Hold down **A** until the display clears. "OFF" or the temperature value should be flashing on the display.

3. Press **C** to show the barometric pressure calibration display. At this time, "OFF" or the barometric pressure value should be flashing on the display.
  - The "OFF" indicator appears when the factory setting is being used for the calibration.
4. Each press of **D** increases the displayed barometric pressure by 1 hPa/mb, while pressing **B** decreases it. Holding down either button changes the value at high speed.
  - Pressing **B** and **D** at the same time returns to the "OFF" display.
5. After calibrating the barometric pressure, press **A** to return to the Barometric Pressure/Temperature Display.
  - If you do not operate any button for a few minutes while the barometric pressure digits are flashing, the flashing stops and the watch goes back to the Barometric Pressure/Temperature Display.

## THERMOMETER FUNCTIONS

A built-in temperature sensor measures temperature and shows the measured value on the display. The thermometer can be calibrated.

### Important!

Temperature measurements are affected by your body temperature (while you are wearing the watch), direct sunlight, and moisture. To achieve a more accurate temperature measurement, remove the watch from your wrist, place it in a well ventilated location out of direct sunlight, and wipe off all moisture from the case. It takes approximately 20 to 30 minutes for the case of the watch to reach the actual surrounding temperature.

### About temperature measurements

Temperature measurements are taken automatically every five minutes, regardless of what mode the watch is in. Measured temperature values can be viewed in the Timekeeping or Altimeter Modes. Temperature measurements are taken every five seconds for the first three minutes after you display the Timekeeping Mode's Barometric Pressure/Temperature display, or after you enter the Altimeter Mode. After that, temperature measurements are taken every five minutes.

- Temperature measurement data can be recalled along with altitude measurement data. For details, see **About memory data**.

### Understanding the temperature display

1. Use **C** to enter the Timekeeping Mode.
2. Press **D** to display the Barometric Pressure/Temperature Display.

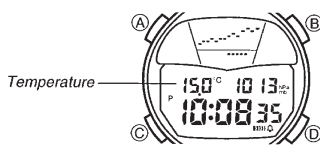

( Barometric Pressure/Temperature Display )

- The display shows "— — °C" if a measured value falls outside the range of -20.0°C to 60.0°C. The normal display will return as soon as the temperature returns within the allowable range.
- For details on viewing the temperature in the Altimeter Mode, see **Understanding the altimeter display**.

### Calibrating the temperature measurement

The temperature sensor of this watch is calibrated at the factory before shipment and further adjustment is normally not required. If noticeable error is found in the temperature readings produced by the watch, you can adjust it to correct the error.

### Important!

- Incorrectly calibrating the temperature measurement of this watch can result in incorrect readings. Carefully read the following before doing anything.
- Compare the readings produced by the watch with those of another reliable, accurate thermometer.
  - If adjustment is required, remove the watch from your wrist and wait for 20 or 30 minutes to give the temperature of the watch time to stabilize.

### To calibrate the temperature

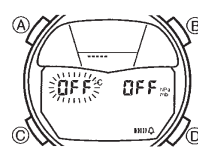

1. In the Timekeeping Mode, use **D** to display the barometric pressure and temperature.
2. Hold down **A** until the display clears. "OFF" or the temperature value should be flashing on the display.
  - The "OFF" indicator appears when the factory setting is being used for the calibration.

3. Each press of **D** increases the displayed temperature by 0.1°C while pressing **B** decreases it. Holding down either button changes the value at high speed.
  - Pressing **B** and **D** at the same time returns to the "OFF" display.
4. After calibrating the temperature, press **A** to return to the Barometric Pressure/Temperature Display.
  - If you do not operate any button for a few minutes while the temperature digits are flashing, the flashing stops and the watch goes back to the Barometric Pressure/Temperature Display.

## ALTIMETER FUNCTIONS

A built-in altimeter uses a pressure sensor to detect the current air pressure, which is then used to estimate the current altitude in accordance with ISA (International Standard Atmosphere) values for altitude and air pressure. If you preset a reference altitude, the watch will also calculate the current relative altitude based on your preset value. Altimeter functions also include data storage memory and an altitude alarm.

### Important!

- This watch estimates altitude based on air pressure. This means that altitude readings for the same location may vary if air pressure changes.
- Sudden changes in the weather make it impossible to produce accurate altitude readings.
- This watch employs a semiconductor pressure sensor, which is affected by temperature changes. When taking altitude measurements, be sure to do so while ensuring that the watch is not exposed to temperature changes.
- Do not use this watch while participating in sports where there are sudden altitude changes. Also, do not use this watch for applications that demand professional or industrial level precision. This watch should not be used while engaging in the following activities: sky diving, hang gliding, paragliding, gyrocopter riding, glider riding, etc.

### Applications

#### When no reference altitude is preset:

- The watch produces approximate altitude readings.

#### When a reference altitude is preset:

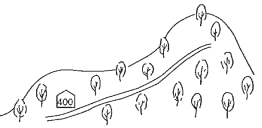
- Before beginning the climb, set the reference altitude to 0 m at the foot of the mountain. This makes it possible to determine the difference in altitude between the reference point and your destination.
 
- To determine the height of a tall building, set the reference altitude to 0 m on the ground floor. Note, however, that if the building is pressurized or air conditioned, you may not be able to get a good reading.
- To determine the difference in altitude between your house and another location, set the reference altitude to 0 m at your house, and then check the reading when you arrive at the other location.
- When mountain climbing, you can input the altitude from a marker as your reference altitude, which will then let you know your altitude as your climb proceeds. The following conditions will prevent you from obtaining accurate readings:
 

When air pressure changes because of changes in the weather  
 Extreme temperature changes  
 When the watch itself is subjected to strong impact

### About altitude measurements

There are two types of altitude measurements: those for displayed data (Altimeter Mode measurement) and those for memory data (memory measurements; See **Memory measurements**).

#### Altimeter Mode measurement

This type of measurement is performed only when the watch is in the Altimeter Mode. As soon as you enter the Altimeter Mode, measurements are taken every five seconds for the first three minutes. After that, measurements are taken every two minutes. The display unit for Altimeter Mode measurements is 5 m, and the display range is 0 to 6000 m.

- The measured altitude may be a negative value in cases where there is a reference altitude value set or because of certain atmospheric conditions.



## Understanding the altimeter display

Use **(C)** to enter the Altimeter Mode. Note that once you enter the Altimeter Mode, if you do not press any button for 10 or 11 hours, the watch automatically returns to the Timekeeping Mode.

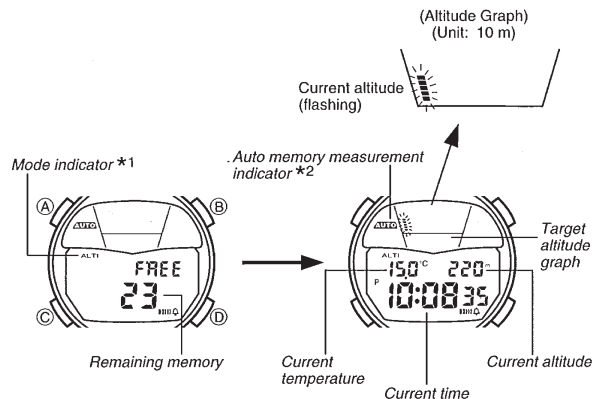

\*1 "ALTI" flashes while a measurement is being taken every five seconds. It does not flash during the measurements taken every two minutes.

\*2 "AUTO" flashes on the display while a memory measurement is in progress. The indicator stops flashing while no measurement is being performed.

## Memory measurements

Memory measurements are taken independently of Altimeter Mode measurements and stored directly into memory (along with temperature measurements) for later recall. There are two types of memory measurements: "Auto Memory Measurements" and "Manual Memory Measurements".

### Auto Memory Measurements

With auto memory measurement, the watch continuously performs measurements whenever the minutes in the Timekeeping Mode reach 00, 15, 30, or 45, until you switch auto measurements off. The watch continues to take measurements regardless of whether or not you change modes, so you can keep a running log of temperature and altitude changes automatically.

### Manual Memory Measurements

You can use the manual procedure to take a reading anytime you want to store your current altitude data into memory for later recall. Manual memory measurements can be performed only while the watch is in the Altimeter Mode.

### About the memory...

Each memory item (auto or manual) stored by the watch consists of the current altitude, plus the month, date, time, and temperature. Data is stored in the same sequence that it is input.

Memory can hold a total of 50 sets of data, which is enough to store 12 hours and 15 minutes of auto memory data (if you do not take any manual readings during that time). See **About memory data** for details on how to recall memory data.

### Important!

Further auto or manual memory measurements become impossible whenever memory is full. The message "FULL" on the display indicates that memory is full. Always check the amount of memory remaining before starting memory measurements, and delete data if necessary.

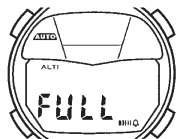

## Selecting Auto or Manual Memory Measurement

Use the following procedure to switch between auto or manual memory measurement. Note that you cannot perform this operation while a preset auto memory measurement is already in progress.

1. In the Altimeter Mode, hold down **(A)** until the display clears. After 4 or 5 seconds, either "OFF" or the current reference altitude value (if set) will start to flash. The data flashes because it is *selected*.
2. Press **(C)** to change the selection in the following sequence.

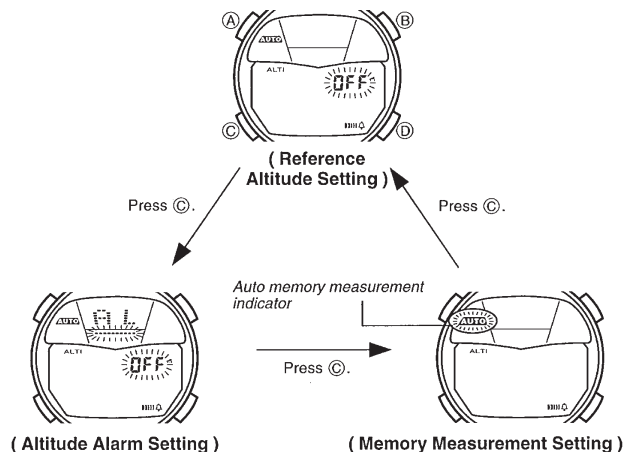

3. Press **(C)** to select the Memory Measurement Setting display (with either "AUTO" or "MANUAL" flashing).
4. Press **(D)** to switch between auto memory measurement ("AUTO" flashing) or manual memory measurement ("MANUAL" flashing).
5. After selecting the type of measurement you want, press **(A)** to return to the Altimeter Mode.

## Using Auto Memory Measurement

Auto memory measurement indicator

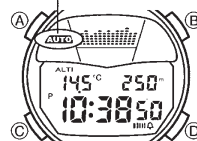

1. Confirm that the "AUTO" indicator is shown on the display. If it is not, use the procedures under **Selecting Auto or Manual Memory Measurement** to select auto memory measurement.

2. Hold down **(D)** until the watch emits a short beep, indicating the start of the measurement.

- The data measured when you first start auto memory measurement is also stored into memory.

- The "AUTO" indicator flashes on the display when you start auto memory measurements. The "AUTO" indicator continues to flash (indicating that measurements continue) even if you change modes.
  - Auto memory measurement cuts off automatically whenever there are 49 sets of data stored in memory. The 50th set of data measured when you stop the measurement operation in step 3 below is also stored in memory.
3. To stop measurements at any point, hold down **(D)** again until the watch emits a short beep.
  - A final measurement is taken when you switch auto memory measurement off, and that data is also stored into memory. Such data is indicated by "FIN" during the recall operation.

## Using Manual Memory Measurement

Manual memory measurement indicator

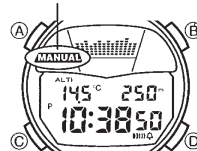

1. Confirm that the "MANUAL" indicator is shown on the display. If it is not, use the procedures under **Selecting Auto or Manual Memory Measurement** to select manual memory measurement.

2. Hold down **(D)** until the watch emits a short beep, indicating that a measurement is taken.

3. Repeat step 2 whenever you want to take a reading.

- Button operation becomes impossible during the 4 or 5 seconds that it takes to complete a measurement. Normal operation will return once the operation is finished.

## Setting a Reference Altitude

After you set a reference altitude, the watch automatically calculates the difference between the current altitude and your preset value. The altitude measurements produced by this watch are subject to error caused by changes in air pressure. Because of this, we recommend that you set the reference altitude during your climb whenever one is available.

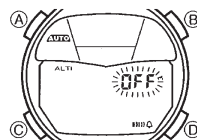

1. In the Altimeter Mode, hold down **(A)** until the display clears. After 4 or 5 seconds, either "OFF" or the current reference altitude value (if set) will start to flash. The data flashes because it is *selected*.

- The "OFF" indicator appears when the factory setting is being used for the calibration.

2. Press **(D)** to increase the current reference altitude value by 5 m or **(B)** to decrease it. Holding down either button changes the value at high speed.
  - You can set the reference altitude within the range of -6000 m to 6000 m.
  - Pressing **(B)** and **(D)** at the same time returns to the "OFF" message.
3. After setting the reference altitude you want, press **(A)** to return to the Altimeter Mode.

## About the Altitude Alarm

The altitude alarm sounds for about five seconds whenever the current altitude matches a preset value. You can press any button to stop the alarm after it starts to sound.

### Example

If you set the altitude alarm at 130 meters, it will sound when you pass the 130-meter mark on your way up and on your way back down.

### To set the altitude alarm

- In the Altimeter Mode, hold down (A) until the display clears. After 4 or 5 seconds, either "OFF" or the current reference altitude value (if set) will start to flash. The data flashes because it is *selected*.
- Press (C) to change the selection in the following sequence.

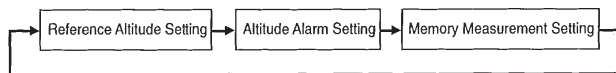

Altitude alarm on indicator

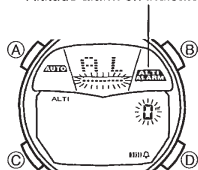

- Press (C) to select the altitude alarm setting display (indicated by the "AL" indicator).
- Press (D) to increase the altitude alarm value by 5 m or (B) to decrease it. Holding down either button changes the value at high speed.
- You can set the altitude alarm setting within the range of -6000 m to 6000 m.
- Setting an altitude value automatically switches the altitude alarm on.

- After setting the altitude alarm value, press (A) to return to the Altimeter Mode.

### To switch the altitude alarm off

- In the Altimeter Mode, hold down (A) until the display clears. After 4 or 5 seconds, either "OFF" or the current reference altitude value (if set) will start to flash. The data flashes because it is *selected*.
- Press (C) to change the selection in the following sequence.

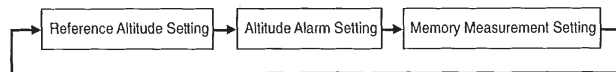

- Press (C) to select the altitude alarm setting display (indicated by the "AL" indicator).
- Press (D) and (B) at the same time to change the setting to "OFF" and switch the altitude alarm off.
- After switching the altitude alarm off, press (A) to return to the Altimeter Mode.

## About the Target Altitude Graph



Target altitude graph

The Target Altitude Graph divides the difference between your start point\* altitude and the value you set for the altitude alarm into 10 equal parts. It then shows a graph that shows your current location, to give you some idea of how much farther you must go to reach your altitude setting.

- \* The start point differs according to what type of memory measurement procedure you are using. With auto memory measurements ("AUTO" shown on the display), the start point is the first altitude measured. With manual memory measurements ("MANUAL" shown on the display), the start point is 0 m.

- The target altitude graph is not shown on the display if the altitude alarm is off.

### Example:

- The display below would appear at a current altitude of 160 m when you are using manual memory measurement with a target altitude setting of 200 m. Eight points on the graph are darkened because you are 8/10 of the way to your target.



This indicator "▶" appears once you pass the target altitude.

- The display below would appear at a current altitude of 160 m when you are using auto memory measurement with a target altitude setting of 200 m and a starting point of 100 m. Six points on the graph are darkened because you are 6/10 of the way to your target.



## About memory data

Use the following procedures to recall measurement data stored in memory.

### To scroll through data items

- Use (C) to enter the Recall Mode.
  - Press (D) to scroll forward through the stored data items or (B) to scroll backward.
- Holding down either button scrolls through the data items at high speed.
  - The data item that is displayed when you exit the Recall Mode is still displayed the next time you enter the Recall Mode.

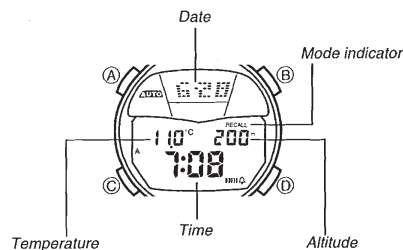

- Measured data is stored in memory even if an error occurs during the measurement. For details on errors, see **Error Warning Function**.

### About the memory data display

Data stored in memory appears in one of the formats shown below, depending on the measurement method (auto or manual), or whether it is the maximum or minimum reading.

- Auto Memory Data

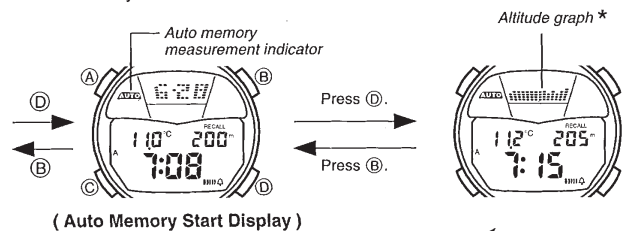

( Auto Memory Start Display )

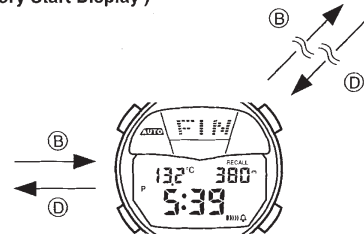

( End Display )

- \* An altitude graph appears in place of the month and date for the display of data between the start and end data. The altitude graph divides by 8 the difference between the maximum and minimum altitudes achieved during the auto memory measurement, and shows relative changes.

- Manual Memory Data

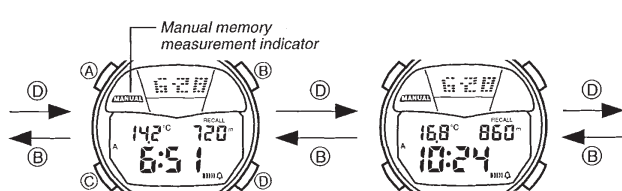

- Maximum/Minimum Data

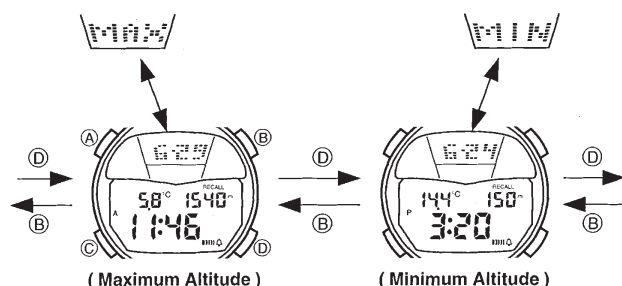

( Maximum Altitude )

( Minimum Altitude )

## Deleting Data

Delete data in the Recall Mode. The actual procedure you should use to delete data depends on the type of data it is.

### To delete auto memory data

The following procedure deletes an entire set (from start measurement to end measurement) of auto memory data.

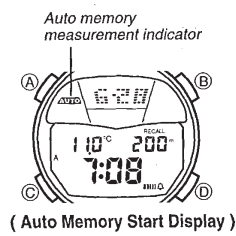

**Important!**  
You cannot delete data while an auto memory measurement is in progress ("AUTO" flashing on the display).

1. In the Recall Mode, display the start data of the set of auto memory data that you want to delete.
2. To clear the data, hold down (A) until the watch emits a beep (and until "CLR" stops flashing on the display).

### To delete manual memory, maximum, and minimum data

1. In the Recall Mode, display the data that you want to delete.
2. To clear the data, hold down (A) until the watch emits a beep (and until "CLR" stops flashing on the display).

## ERROR WARNING FUNCTION

This watch is designed to automatically stop taking measurements when there is a sensor malfunction, when battery power drops below a certain level, or when battery voltage is decreased below a certain level due to very cold temperatures.

### Sensor malfunction

During Barometric Pressure Measurement

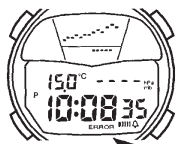

During Altitude Measurement

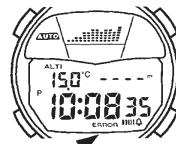

### Low battery

During Barometric Pressure Measurement



During Altitude Measurement

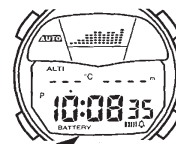

### Important!

- If the sensor is malfunctioning when it comes time for an barometric pressure measurement to be taken, the barometric pressure value appears as "—" on the display and the corresponding point on the barometric pressure graph is left blank.
- There may be cases where the "ERROR" or "BATTERY" message is cleared once you change modes. In this case, you can continue using the watch normally unless the error warning message reappears.

Whenever there is a sensor malfunction, be sure to take the watch to an authorized CASIO distributor or Service Center as soon as possible. If the appearance of the "BATTERY" message is caused by extremely low temperature, the message should clear from the display when normal temperature returns. It is recommended, however, that you still have the watch checked by an authorized CASIO distributor or Service Center.

## ALARM FUNCTIONS

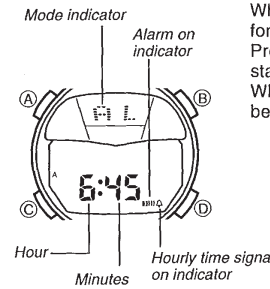

When the Daily Alarm is on, the alarm sounds for 20 seconds at the preset time each day. Press any button to stop the alarm after it starts to sound.  
When the Hourly Time Signal is on, the watch beeps every hour on the hour.

### To set the alarm time

1. Use (C) to enter the Alarm Mode.
2. Hold down (A) until the hour digits flash on the display. The hour digits flash because they are *selected*.
- At this time, the alarm is automatically switched on.
3. Press (C) to change the selection in the following sequence.



4. Press (D) to increase the selected digits. Holding down (D) changes the selection at high speed.
- The format (12-hour and 24-hour) of the alarm time matches the format you select for normal timekeeping.
- When setting the alarm time using the 12-hour format, take care to set the time correctly as morning (A) or afternoon (P).
5. After you set the alarm, press (A) to return to the Alarm Mode.

### To switch the Daily Alarm and Hourly Time Signal on and off

Press (D) while in the Alarm Mode to change the status of the Daily Alarm and Hourly Time Signal in the following sequence.

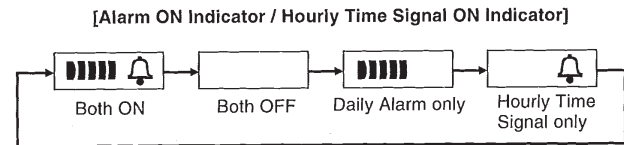

### To test the alarm

Hold down (D) while in the Alarm Mode to sound the alarm.

## STOPWATCH FUNCTIONS

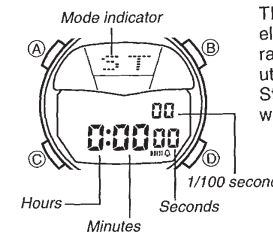

The Stopwatch Functions let you record elapsed time, split times, and two finishes. The range of the stopwatch is 23 hours, 59 minutes, 59.99 seconds. Stopwatch functions are available in the Stopwatch Mode, which you can enter using (C).

### (a) Elapsed time measurement



### (b) Split time measurement



### (c) Split time and 1st-2nd place times

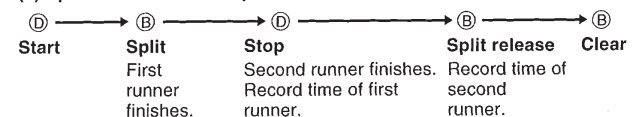

# ABOUT ALTITUDE AND AIR PRESSURE MEASUREMENTS

## Altimeter

Generally, air pressure and temperature decrease as altitude increases. This watch bases its altitude measurements on International Standard Atmosphere (ISA) values stipulated by the International Civil Aviation Organization (ICAO), which define relationships between altitude, air pressure, and temperature.

ALTITUDE	AIR PRESSURE	TEMPERATURE
6000 m	472 hPa/mb	-24°C
5500 m	540 hPa/mb	-17.5°C
5000 m		
4500 m	616 hPa/mb	-11°C
4000 m		
3500 m	701 hPa/mb	-4.5°C
3000 m		
2500 m	795 hPa/mb	2°C
2000 m		
1500 m	899 hPa/mb	8.5°C
1000 m		
500 m	1013 hPa/mb	15°C
0 m		

About 6.7 hPa/mb per 100 m  
About 7 hPa/mb per 100 m  
About 8 hPa/mb per 100 m  
About 9 hPa/mb per 100 m  
About 10 hPa/mb per 100 m  
About 11 hPa/mb per 100 m  
About 12 hPa/mb per 100 m

About 6.5°C per 1000 m

Source: International Civil Aviation Organization

There are two standard methods of expressing altitude: Absolute altitude and relative altitude. Absolute altitude expresses an absolute height above sea level. Relative altitude expresses the difference between the height of two different places.

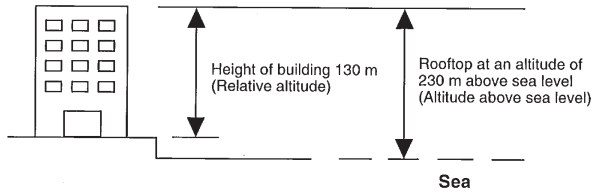

## Barometer

Barometric pressure indicates changes in the atmosphere, and by monitoring these changes you can predict the weather with reasonable accuracy. Rising barometric pressure indicates good weather, while falling pressure indicates deteriorating weather conditions.

The barometric pressures that you see in the newspaper and on the TV weather report are measurements corrected to values measured at 0 m sea level.